

VULCAN

INSTALLATION & OPERATION MANUAL

VG30, VG40, VE30 & VE40 BRAISING PANS

MODELS

VG30	ML-126847
VG40	ML-126848
VE30	ML-126849
VE40	ML-126850



For additional information on Vulcan-Hart Company or to locate an authorized parts and service provider in your area, visit our website at www.vulcanhart.com

IMPORTANT FOR YOUR SAFETY

THIS MANUAL HAS BEEN PREPARED FOR PERSONNEL QUALIFIED TO INSTALL GAS EQUIPMENT, WHO SHOULD PERFORM THE INITIAL FIELD START-UP AND ADJUSTMENTS OF THE EQUIPMENT COVERED BY THIS MANUAL.

POST IN A PROMINENT LOCATION THE INSTRUCTIONS TO BE FOLLOWED IN THE EVENT THE SMELL OF GAS IS DETECTED. THIS INFORMATION CAN BE OBTAINED FROM THE LOCAL GAS SUPPLIER.

IMPORTANT

IN THE EVENT A GAS ODOR IS DETECTED, SHUT DOWN UNITS AT MAIN SHUTOFF VALVE AND CONTACT THE LOCAL GAS COMPANY OR GAS SUPPLIER FOR SERVICE.

FOR YOUR SAFETY

DO NOT STORE OR USE GASOLINE OR OTHER FLAMMABLE VAPORS OR LIQUIDS IN THE VICINITY OF THIS OR ANY OTHER APPLIANCE.

⚠ WARNING Improper installation, adjustment, alteration, service or maintenance can cause property damage, injury or death. Read the installation, operating and maintenance instructions thoroughly before installing or servicing this equipment.

IN THE EVENT OF A POWER FAILURE, DO NOT ATTEMPT TO OPERATE THIS DEVICE.

TABLE OF CONTENTS

GENERAL	4
INSTALLATION	4
Unpacking	4
Location	4
Installation Codes and Standards	6
Leveling and Anchoring the Tilting Braising Pan.....	6
Service Connections	6
Testing the Gas Supply System	7
Gas Connections	7
Flue Connections	7
Electrical Connections	8
Installation Diagram	9
OPERATION.....	10
Before First Use	10
Gas Heat Braising Pans.....	10
Electric Heat Braising Pans	12
Operation of the Lifting System	12
Unloading Prepared Foods	13
Steaming Inserts (Optional)	14
Cooking Hints.....	14
Cleaning.....	15
Cooking Guidelines (Domestic Measurements)	16
Cooking Guidelines (Metric Measurements)	19
MAINTENANCE.....	22
Lubrication	22
Adjustments	22
Vent	22
Service and Parts Information	22
TROUBLESHOOTING	23
Gas Heat Braising Pans.....	23
Electric Heat Braising Pans	23
SERVICE AND PARTS INFORMATION.....	24

Installation, Operation and Care of TILTING BRAISING PANS MODELS VG30, VG40, VE30 & VE40

SAVE THESE INSTRUCTIONS FOR FUTURE USE

GENERAL

Vulcan-Hart Tilting Braising Pans are available in two sizes. Models VG30 and VE30 have a 30-gallon (114 L) capacity, and Models VG40 and VE40 have a 40-gallon (151 L) capacity.

The tilting braising pan is a versatile piece of equipment. It allows you to stew, simmer, pan fry, braise, grill or saute, and all with a very uniform heat pattern.

Standard features on all models include thermostat, manual lift, drop-away food pan support and four flanged feet.

Optional features include automatic power lift and casters.

Your Vulcan braising pan is produced with quality workmanship and material. Proper installation, usage and maintenance will result in many years of satisfactory performance.

Vulcan-Hart suggests that you thoroughly read this entire manual and carefully follow all of the instructions provided.

INSTALLATION

Before installing, verify that the electrical service and gas supply (natural or propane) agree with the specifications on the rating plate located on the left front edge of the table top.

UNPACKING

This braising pan was carefully inspected before leaving the factory. The transportation company assumes full responsibility for safe delivery upon acceptance of this shipment.

Immediately after unpacking, check for possible shipping damage. If the tilting braising pan is found to be damaged, save the packaging material and contact the carrier within 15 days of delivery.

LOCATION

For Gas-Powered Braising Pans Only

The braising pan must be kept free and clear from combustible substances. The braising pan, when installed, must have minimum clearance from combustible construction of 2" (5 cm) from the sides and 6" (15 cm) from the rear. Minimum clearance from noncombustible construction is 0" from the sides and 6" (15 cm) from the rear.

The installation location must allow adequate clearances for servicing and proper operation. Recommended clearances are 24" (61 cm) on the sides and back (for servicing), and 36" (91 cm) on the front.

The braising pan must be installed so that the flow of combustion and ventilation air will not be obstructed. Adequate clearance for air openings into the combustion chamber must be provided. Make sure there is an adequate supply of air in the room suitable for the amount of combustion gas feeding the braising pan burners.

Do not permit fans to blow directly at the braising pan. Wherever possible, avoid open windows next to the braising pan. Avoid wall-type fans which create air cross currents within the room.

Gas-Powered Braising Pans Equipped with Casters (Optional)

If casters are assembled to the braising pan, the installation must be made using:

1. A connector (not supplied by Vulcan) that complies with the Standard for *Connectors for Movable Gas Appliances*, ANSI Z21.69 (latest edition) or *Connectors for Moveable Gas Appliances*, CAN/CGA-6.16 (latest edition).
2. A quick-disconnect device that complies with the Standard for *Quick-Disconnect Devices for Use With Gas Fuel*, ANSI Z21.41 or *Quick-Disconnect Devices for Use with Gas Fuel*, CAN1-6.9 (latest edition).

Adequate means must be provided to limit the movement of the appliance, without depending on the connector and/or any quick-disconnect device or its associated piping to limit braising pan movement. Attach the restraint at the rear of the braising pan (Fig. 1). If disconnection of the restraint is necessary, turn off the gas supply before disconnection. Reconnect this restraint prior to turning the gas supply on and prior to returning the braising pan to its originally installed position.

Electric-Powered Braising Pans Equipped with Casters (Optional)

If casters are assembled to the braising pan, the appliance shall be installed using flexible conduit.

Safety standards require that, when a electric Braising Pan electric supply line is properly connected to the electrical power supply, an adequate means must be provided to limit movement of the appliance without depending on or transmitting stress to the electrical conduit.

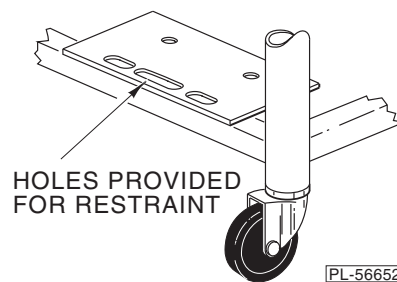

Fig. 1

If disconnection of the restraint is necessary, turn off the gas and/or electric supplies before disconnection. Reconnect this restraint prior to turning the gas and/or electric supplies on and prior to returning the braising pan to its originally installed position.

INSTALLATION CODES AND STANDARDS

The Vulcan braising pan must be installed in accordance with:

In the United States of America:

1. State and local codes.
2. National Fuel Gas Code, ANSI-Z223.1/NFPA #54 (latest edition). Copies may be obtained from The American Gas Association Accredited Standards Committee Z223, @ 400 N. Capital St. NW, Washington, DC 20001, or the Secretary Standards Council, NFPA, 1 Batterymarch Park Quincy, MA 02169-7471.
3. NFPA Standard # 96 Vapor Removal from Cooking Equipment, latest edition, available from the National Fire Protection Association, Batterymarch Park, Quincy, MA 02269.
4. In the Commonwealth of Massachusetts all gas appliances vented through a ventilation hood or exhaust system equipped with a damper or with a power means of exhaust shall comply with 248 CMR.

In Canada:

1. Local codes.
2. CAN/CSA-B149.1 Natural Gas Installation (latest edition).
3. CAN/CSA-B149.2 Propane Installation Code (latest edition), available from the Canadian Gas Association, 178 Rexdale Blvd., Etobicoke, Ontario, Canada M9W 1R3.

LEVELING AND ANCHORING THE TILTING BRAISING PAN

1. Place the braising pan in the final installed position.
2. Place a carpenter's level on the braising pan table top and turn the adjustable feet to level the braising pan table top side-to-side and front-to-back. Do not attempt to level the braising pan base.
3. Mark hole locations on the floor through the anchoring holes provided in the flanged adjustable feet.
4. Remove the tilting braising pan from the installation location and drill holes in the locations marked on the floor. Insert proper anchoring devices (not supplied).
5. Place the tilting braising pan back in the installation location.
6. Place a carpenter's level on top of the braising pan, and re-level side-to-side and front-to-back.
7. Bolt and anchor the tilting braising pan securely to the floor.
8. Seal bolts and flanged feet with Silicon sealant or equivalent compound.

SERVICE CONNECTIONS

To access service and utility connections, remove the left side panel. To remove, hold the panel from underneath and lift it up. While holding the panel up, swing out the lower part of the panel until it clears the bottom flange and remove the panel. If required, the rear panel can also be removed using the same procedure.

The gas-powered braising pan is supplied with a 120-volt power cord.

The electrical connection for the electric braising pan can be accessed from the rear or the left panel.

TESTING THE GAS SUPPLY SYSTEM

When test pressures exceed $\frac{1}{2}$ psig (3.45 kPa), the tilting braising pan and its individual shutoff valve must be disconnected from the gas supply piping system.

When test pressures are $\frac{1}{2}$ psig (3.45 kPa) or less, the tilting braising pan must be isolated from the gas supply system by closing its individual manual shutoff valve.

GAS SUPPLY CONNECTION (See Fig. 2)

All gas supply connections and any pipe joint compound used must be resistant to the action of propane gases.

Connect a $\frac{3}{4}$ " (nominal) gas supply to the braising pan. Recommended incoming gas line pressure is 7" W.C. (Water Column) (48.3 kPa) for natural gas or 11" W.C. (75.8 kPa) for propane gas.

Gas pressure should not exceed 14" W.C., higher pressure will damage the combination valve.

Make sure the pipes are clean and free of obstructions, dirt and piping compound.

Codes require that a gas shutoff valve be installed in the gas line ahead of the tilting braising pan.

Natural gas and propane gas braising pans are equipped with fixed orifices, and gas pressure must be verified at start up. The manifold is set at 3.7" W.C. (Water Column) (25.5 kPa) for natural gas and 10" W.C. (68.9 kPa) for propane gas.

⚠ WARNING Prior to lighting, check all joints in the gas supply line for leaks. Use soap and water solution. Do not use an open flame.

After piping has been checked for leaks, all piping receiving gas should be fully purged to remove air.

VENTILATION

DO NOT obstruct the flow of flue gases from the flue duct located on the rear of the tilting braising pan. It is recommended that the flue gases be ventilated to the outside of the building through a ventilation system installed by qualified personnel.

From the termination of the braising pan flue vent to the filters of the hood venting system, an 18" (46 cm) minimum clearance must be maintained. The flue is not to be directly connected to the ventilation system.

Local jurisdictions may require a ventilation system to exhaust the steam from this appliance. Clearance of 40" is recommended for the lid to be raised without interference with the hood. A ceiling that is too low may not allow for an installation of a hood to meet this requirement.

ELECTRICAL CONNECTIONS (See Fig. 2)



⚠ WARNING Disconnect the electrical power to the machine and follow Lockout / Tagout procedures.

⚠ WARNING Appliances equipped with a flexible electric supply cord are provided with a three-prong grounding plug. It is imperative that this plug be connected into a properly grounded three-prong receptacle. If the receptacle is not the proper grounding type, contact an electrician. do not remove the grounding prong from this plug.

⚠ WARNING Electrical and grounding connections must comply with the national electrical code and/or other local codes.

The field connection box for field wire connection of Models VE30 and VE40 is located at the back of the braising pan. A knockout hole is provided for a 1" (2.5 cm) conduit connection.

1. Remove the field connection box cover plate. Mount suitable 1" (2.5 cm) conduit fitting in the conduit opening provided on the bottom surface.
2. Connect field wire to the terminal block as indicated on the wiring diagram. The wiring diagram is located on the inside of the field box lid. Wire must be of the type suitable for 75°C service and at the suitable gauge for loads shown on the data plate.
3. After making the connections, replace the control box cover plate.
4. The braising pan must be grounded by installing a properly grounded lead to the ground lug located inside the field connection box.
5. The electronic ignition used to light the burners require proper grounding.

ELECTRICAL DATA CHART							
VOLTS	PHASE	VE30		VE40			
		K.W.	AMP	K.W.	LX	LY	LZ
208	1	9	43	12	58	58	—
240	1	12	50	16	67	67	—
208	3	9	25	12	39	39	25
240	3	12	29	16	46	46	29
480	3	12	15	16	23	23	15

These values are nominal ratings. Field wire connections must be capable of withstanding anticipated surges.

INSTALLATION DIAGRAM

SERVICE CONNECTIONS:

1. GAS BRAISING PAN:



GAS INPUT: 3/4" N.P.T., Nat.5"-10.5" W.C., propane gas 11" - 13" W.C., See capacity chart.

Supply gas pressure not to exceed 14" W.C.

ELECTRICAL: Machine is supplied with 120-VAC, 1-phase, 15-amp. power cord.

2. ELECTRICAL BRAISING PAN:



ELECTRICAL CONNECTION: 1" dia. conduit, fitting to be installed by installer.

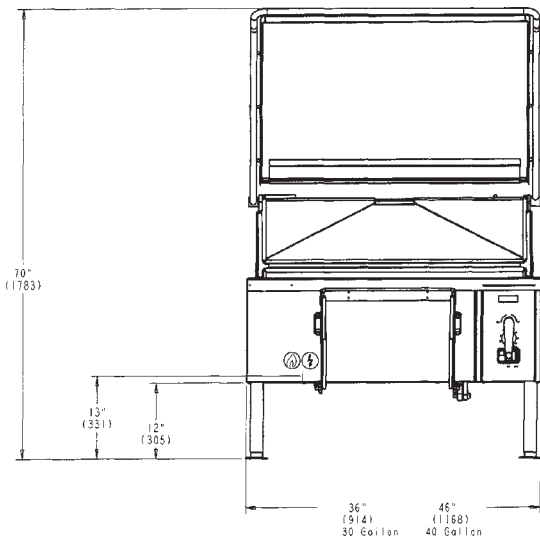
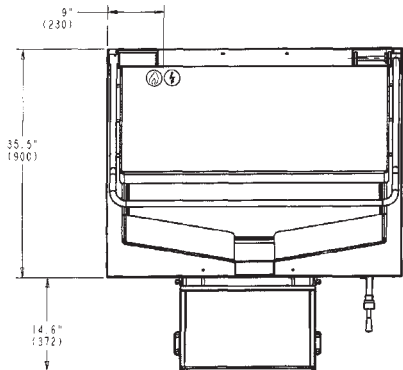
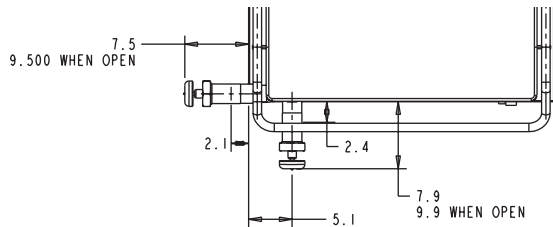

IMPORTANT

1. A pressure regulator sized for this unit is included. Natural gas 7" W.C., propane gas 11" W.C. supply pressure.
2. Gas line connecting to appliance must be 3/4" or larger. If flexible connectors are used, the inside diameter must be at least the same as the 3/4" iron pipe.
3. An adequate ventilation system is required for commercial cooking equipment. Information may be obtained by writing to the National Fire Protection Association, Batterymarch Park, Quincy, MA 02289. When writing, refer to NFPA No. 96.
4. These units are manufactured for installation in accordance with National Fuel Gas Code, ANSI-Z223.1/NFPA #54 (latest edition). Copies may be obtained from The American Gas Association Accredited Standards Committee Z223, @ 400 N. Capital St. NW, Washington, DC 20001, or the Secretary Standards Council, NFPA, 1 Batterymarch Park Quincy, MA 02169-7471.
5. Clearances:

	Combustible	Noncombustible
Rear	6	6
Sides	2	0
6. This appliance is manufactured for commercial installation only and is not intended for home use.

MODEL	BTU/hr. Input
VG30	90,000
VG40	120,000

MODEL	208 VAC	240 VAC	480 VAC
VE30	9 KW	12 KW	12 WK
VE40	12 KW	16 KW	16 KW

MODEL	Cooking Surface Area	Capacity	4 oz. Portions
VE/VG30	29" x 23"	30 gal./114 liters	960
VE/VG40	39" x 23"	40 gal./152 liters	1280

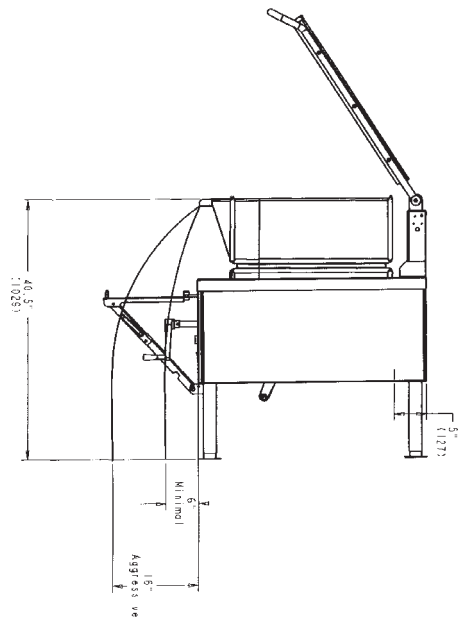

Fig. 2

OPERATION

⚠ WARNING The tilting braising pan and its parts are hot. Use care when operating, cleaning or servicing the braising pan.

BEFORE FIRST USE

Use a noncorrosive, grease-dissolving commercial cleaner to clean the protective metal oils from all surface parts and the interior of the tilting braising pan. Follow the cleaner manufacturer's directions. Rinse thoroughly and drain the pan. Wipe dry with a soft, clean cloth.

GAS HEAT BRAISING PANS

Controls (Fig. 3)

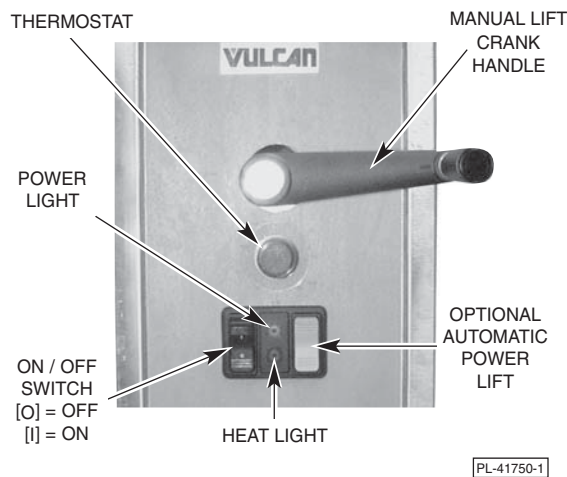

Fig. 3

- Thermostat — Sets desired cooking temperature.
- On/Off Switch (Black) — Turns the braising pan on and off.
- Power Light (Amber) — When lit, indicates the machine is turned on.
- Heat Light (Red) — When lit, indicates the thermostat is calling for heat.
- Auto. Power Lift (Gray) — (Optional). Push the upper part of the switch to raise the braising pan; push the lower part to lower the braising pan. Always remove the manual lift crank handle before operating the automatic power lift.
- Manual Lift Crank Handle — Use to manually raise and lower the braising pan.

Lighting and Shutdown of Pilot

Lighting instructions are also located on the front panel.

1. Turn main gas supply to the braising pan to the ON position at the shutoff valve.
2. Lower the braising pan (see OPERATION OF LIFTING SYSTEM in this manual). The braising pan will not operate with the pan in the UP position (5 degrees or higher from horizontal).
3. Turn the black on/off switch to the ON position. The ON position is indicated by a glowing amber light on the control panel.
4. Turn the thermostat to the desired cooking temperature.
5. If pilot is extinguished, turn the gas supply and the on/off switch to the OFF position. Wait 5 minutes before relighting.

Nightly Shutdown

1. Return pan to the down position.
2. Turn the on/off switch to the OFF position.

Extended Shutdown

Turn the on/off switch to the OFF position and turn off the gas supply.

Operating the Gas Braising Pan

The entire flue duct opening (located across the rear of the braising pan) must be left uncovered.

Turn the on/off switch to the ON position and turn the thermostat to the desired temperature to put the braising pan into operation.

To prevent discoloration of the stainless steel cooking surface, do not turn the heat on unless the braising pan is covered with a fluid, a thin layer of cooking oil, or food.

DO NOT use the braising pan as a **deep fat fryer**; use it only for shallow pan frying (cooking oil film not more than $\frac{1}{8}$ " [0.3 cm] thick). Its use for deep frying could result in a fire hazard. See COOKING HINTS in this manual for additional information.

Do not overheat the clad stainless steel plate by setting the temperature well above recommended temperatures or by operating the braising pan without any fluid inside the pan to absorb heat. Overheating the plate may cause warpage and will carbonize any food or cooking oil on the plate and cause sticking.

In case of a power failure, the combination control valve will shut off the gas flow. In the event of a power failure, immediately turn the on/off switch to the OFF position. Once power is restored, turn the on/off switch to the ON position to resume cooking.

The lid is spring-loaded and will stay in any position at which it is placed. After some time, the springs may need to be tightened. Call your local Vulcan-authorized servicer to make these adjustments.

ELECTRIC HEAT BRAISING PANS

Controls (see Fig. 3)

- Thermostat — Sets desired cooking temperature.
- On/Off Switch (Black) — Turns the braising pan on and off.
- Power Light (Amber) — When lit, indicates the machine is turned on.
- Heat Light (Red) — When lit, indicates the thermostat is calling for heat.
- Auto. Power Lift (Gray) — (Optional). Push the upper part of the switch to raise the braising pan; push the lower part to lower the braising pan. Always remove the manual lift crank handle before operating the automatic power lift.
- Manual Lift Crank Handle — Use to manually raise and lower the braising pan.

Operating the Electric Braising Pan

Turn the black on/off switch to the ON position.

Lower the braising pan (see OPERATION OF LIFTING SYSTEM in this manual). The braising pan will not operate with the pan in the UP position (5 degrees or higher from horizontal).

Turn the thermostat to the desired cooking temperature.

To prevent discoloration of the stainless steel cooking surface, do not turn the heat on unless the braising pan surface is covered with a fluid, a thin layer of cooking oil, or food.

DO NOT use the braising pan as a **deep fat fryer**; use it only for shallow pan frying (cooking oil film not more than 1/8" [0.3 cm] thick). Its use for deep frying could result in a fire hazard. See COOKING HINTS in this manual for additional information.

Do not overheat the clad stainless steel plate by setting the temperature well above recommended temperatures or by operating the braising pan without any fluid inside the pan to absorb heat. Overheating the plate may cause warpage and will carbonize any food or cooking oil on the plate and cause sticking.

The lid is spring-loaded and will stay in any position at which it is placed. After some time, the springs may need to be tightened. Call your local Vulcan-authorized servicer to make these adjustments.

OPERATION OF THE LIFTING SYSTEM

Keep the area underneath and around the braising pan clear of your hands or any other objects when operating the lifting system.

Do not obstruct any of the moving parts of the lift system located underneath the table top on the right and/or left side of the braising pan. This area must be kept clear of any objects or obstructions at all times.

Do not leave the braising pan in the UP position for extended periods (e.g., overnight or during a shutdown period between cooking times).

Braising Pans with Manual Lift (Standard)

1. Raise the lid. The crank for the manual lift system is packaged separately.
2. There are two pins on one end of the crank. Insert the crank through the hole on the control panel so that the two pins engage in the slots of the speed reducer coupling located behind the panel.
3. Turn the crank handle clockwise to lift the braising pan and counterclockwise to lower the braising pan.
4. This lift system is not affected by a power failure and can be operated during a power failure.
5. Refer to the MAINTENANCE section of this manual for lubrication and maintenance instructions.

Braising Pans with Automatic Power Lift (Optional)

1. Raise the lid. The automatic lift cannot raise the braising pan unless the lid is fully opened.
2. The pan lift is controlled by the gray rocker switch located on the control panel (see Fig. 3).
3. Remove the manual crank handle before operating the automatic power lift.
4. Press the upper half of the gray rocker switch to raise the braising pan and the lower half of the gray rocker switch to lower the braising pan. The switch must be held for continuous raising or lowering of the braising pan.
5. In case of a power failure, use the hand crank (packaged separately) to lower or raise the pan (same as the braising pans with manual lift).

UNLOADING PREPARED FOODS

All braising pans are provided with a frame support (Fig. 4) for holding a food receiving pan when unloading prepared foods. Chafing pans do not fit into holder.

Pull the frame support out and up until it locks. The support will accept food receiving pans of 12" x 20" (30 cm x 50 cm) up to 6" (15 cm) deep.

When lowering the frame support, lift by handles until the hinges bend, then lower the support.



Fig. 4

PL-41751-1

STEAMING INSERTS (Optional)

Your tilting braising pan can be used for steaming frozen and fresh foods. The 30-gallon (114 L) pans (Models VE30 or VG30) can be loaded with a maximum of two 12" x 20" x 4" (30 cm x 50.8 cm x 10 cm) deep steaming pans. The 40-gallon (151 L) pan (Models VE40 or VG40) will accept up to three steam pans of this same size.

To use the braising pan for steaming, fill the pan with 6 to 7 gallons (23 to 26 L) of water (approximately 2" [5 cm] deep) for 30-gallon (114 L) models and 8 to 9 gallons (30 to 34 L) of water (approximately 2" [5 cm] deep) for 40-gallon (151 L) models.

Turn the braising pan ON. Set the thermostat at 212°F (100°C). Allow the water to come to a boil. Then change the thermostat setting to 250°F (121°C) and carefully place the steaming inserts into the pan as shown in Fig. 5. Place the pan with product into the steaming insert. Close the lid and allow steaming for the desired time.

Periodically inspect the water level inside the braising pan. Add water if the water level is less than 1/2" (1 cm) deep.

To use the braising pan as a food warmer or bain marie, follow the same procedure as for steaming, but increase the depth of the water to allow the bottom and part of the sides of the steaming inserts to be immersed in water. Set the thermostat for the holding or warming temperature desired.

The steaming inserts can be ordered from your dealer (Part No. 855168).

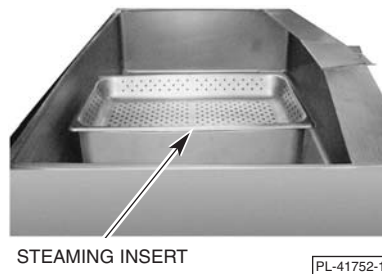

Fig. 5

SUGGESTED USES FOR YOUR BRAISING PAN

DO NOT use the braising pan for **deep fat frying**. Restrict frying activity to shallow pan frying (oil film not more than 1/8" [0.3 cm] thick) or sauteing.

A tilting braising pan is quite versatile. It can be used for roasting, simmering, boiling, sauteing, searing, frying, warming, holding, proofing, thawing, browning, steaming, braising, grilling or stewing. It can be used as an oversized skillet, as a bain marie, as a proofing oven, as a stock pot, as a kettle or as an even-heat range top. It can be used for cooking breakfasts, lunches and dinners.

Your Vulcan tilting braising pan is a multi-purpose unit that can be used for virtually any type of cooking, except deep fat frying, with great speed, in large volume and with considerable savings in labor and energy.

CLEANING



⚠ WARNING Disconnect the electrical power to the machine and follow Lockout / Tagout procedures before cleaning.

Clean your braising pan regularly. Keep the plate surface clean. To produce evenly cooked, perfectly braised products, keep the pan surface free from carbonized grease. Carbonized grease on the surface hinders the transfer of heat from the pan surface to the food. This results in spotty browning and loss of cooking efficiency. Worst of all, carbonized grease tends to cling to the foods, giving them a highly unsatisfactory and unappetizing appearance.

After Each Use

Clean the pan surface with a brush or flexible spatula.

Remove the strainer (Fig. 6) at the pouring lip of the braising pan by pulling it toward the back of the pan. Clean the strainer in a sink. Rinse thoroughly and dry with a soft, clean cloth. Replace strainer.

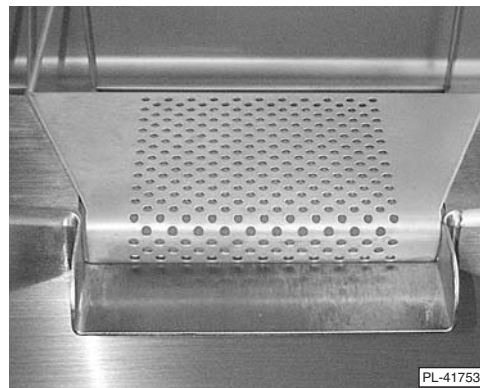

Fig. 6

Once a Day

Thoroughly clean the back, sides and front of the pan. Also clean the inside and outside surfaces of the lid.

Do not hose down or power wash.

Once a Week

Clean the pan surface thoroughly. If necessary, use a griddle stone or brush on the surface. A detergent may be used on the pan surface to help clean it, but be sure the detergent is thoroughly removed.

Clean other stainless steel surfaces with a damp cloth and polish with a soft, dry cloth. To remove discolorations, use a nonabrasive cleaner. If the braising pan usage is very high, consider going through the weekly cleaning procedures more often than once a week.

When cleaning the braising pan, it is helpful to fill the pan with approximately 10 gallons (38 L) of warm water and add detergent. After cleaning, raise the braising pan to drain all water (place a bucket or container under the pouring lip). Then repeat the procedures for rinsing with clean water.

COOKING GUIDELINES (Domestic Measurements)

The guidelines given below are suggested quantities, temperature settings and estimated numbers of orders per load and per hour. When two temperatures are given, the first is to start the product and the second is to finish the product.

The following temperatures should be used:

	Temperature (°F)
Simmering	200 Max.
Sauteing	225 to 275
Searing	300 to 350
Frying	325 to 375
Grilling	350 to 425

ITEM	PORTION SIZE	TEMP. (°F)	BATCHES PER HOUR	VG30/VE30		VG40/VE40	
				QTY.	PORTIONS	QTY.	PORTIONS
BREAKFAST FOODS							
Bacon	3 Slices	350	12	2 lb.	10	3 lb.	15
Eggs							
–Boiled-Hard	1 egg	225	5	50 eggs	50	75 eggs	75
–Boiled-Soft	1 egg	225	8	50 eggs	50	75 eggs	75
–Fried	1 egg	400	4	30 eggs	30	45 eggs	45
–Poached	1 egg	225	5	36 eggs	36	60 eggs	60
–Scrambled	1½ eggs	300 – 200	1	18 gal.	720	28 gal.	1100
French Toast	3 slices	425	7	35 slices	12	50 slices	17
Regular Oatmeal	½ cup	250	2	20 lb (100 cups)	500	40 lb (200 cups)	1000
Pancakes	2 each	400	10	30 ea.	15	50 ea.	25
FISH							
Clams	1 pt.	400	10	10 qts.	20	15 qts.	30
Fish Cakes	2 to 3 oz.	400	5	70 – 3 oz.	35	110 – 3 oz.	55
Haddock Fillet	4 oz.	400	4	60 – 4 oz.	60	90 – 4 oz.	90
Halibut Steak	5 oz.	425	3	60 – 4 oz.	60	90 – 4 oz.	90
Lobster	1 – 1 lb.	350	4	20 – 1 lb.	20	30 – 1 lb.	30
Swordfish	5 oz.	425	3	50 – 5 oz.	50	75 – 5 oz.	75
SAUCES, GRAVIES, SOUPS							
Brown Gravy	1 oz.	350 – 200	2	30 gal.	3840	40 gal.	5120
Cream Sauce	2 oz.	250 – 175	1	30 gal.	1920	40 gal.	2560
Cream Soup	6 oz.	200	1	30 gal.	640	40 gal.	853
French Onion Soup	6 oz.	225	1	30 gal.	640	40 gal.	853
Meat Sauce	4 oz.	350 – 200	1	30 gal.	960	40 gal.	1280

ITEM	PORTION SIZE	TEMP. (°F)	BATCHES PER HOUR	VG30/VE30		VG40/VE40	
				PER LOAD QTY.	PORTIONS	PER LOAD QTY.	PORTIONS
VEGETABLES							
CANNED	3 oz.	400	6	30 lb.	125	45 lb.	200
FRESH							
Beans, Wax, Green	3 oz.	400	3	25 lb.	125	50 lb.	250
Beets	3 oz.	400	1	30 lb.	125	60 lb.	300
Broccoli	3 oz.	400	3	25 lb.	125	40 lb.	200
Cabbage	3 oz.	400	5	20 lb.	80	30 lb.	125
Carrots	3 oz.	400	2	35 lb.	150	70 lb.	300
Cauliflower	3 oz.	250	5	15 lb.	75	25 lb.	125
Corn	1 Ear	400	8	50 ears	50	75 ears	75
Potatoes	3 oz.	400	2	40 lb.	200	60 lb.	300
Spinach	4 oz.	250	10	6 lb.	25	9 lb.	35
Turnips	4 oz.	400	2	20 lb.	100	30 lb.	150
FROZEN							
Beans, French Green	3 oz.	400	6	15 lb.	60	22½ lb.	90
Lima Beans	3 oz.	250	4	15 lb.	60	22½ lb.	90
Broccoli	3 oz.	400	8	12 lb.	50	18 lb.	75
Sliced Carrots	3 oz.	250	6	15 lb.	60	22½ lb.	90
Small Whole Carrots	3 oz.	250	3	15 lb.	50	22½ lb.	90
Corn	3 oz.	250	18	15 lb.	50	22½ lb.	90
Small Whole Onions	3 oz.	250	7	15 lb.	50	22½ lb.	90
Peas	3 oz.	400	10	15 lb.	75	22½ lb.	110
Spinach	3 oz.	400	3	15 lb.	75	22½ lb.	110
DESSERTS, PUDDINGS, SWEET SAUCES							
Butterscotch Sauce	1 oz.	200	1	30 gal.	3840	40 gal.	5120
Cherry Cobbler	3 oz.	200	1	30 gal.	1280	40 gal.	1707
Chocolate Sauce	1 oz.	200	1	30 gal.	3840	40 gal.	5120
Cornstarch Pudding	4 oz.	200	1	30 gal.	960	40 gal.	1280
Fruit Gelatin	3 oz.	250	2	30 gal.	1280	40 gal.	1707
MEAT – POULTRY							
Bacon	3 Slices	350	12	2 lb.	10	3 lb.	15
BEEF							
Amer. Chop Suey	6 oz.	400 – 225	2	30 gal.	640	40 gal.	853
Beef Stew	8 oz.	300	—	30 gal.	480	40 gal.	640
Corned Beef Hash	5 oz.	400	5	20 lb.	60	30 lb.	90
Cheeseburger	3 oz.	300	12	7 lb.	35	10 lb.	50
Hamburger	3 oz.	300	15	7 lb.	35	10 lb.	50
Meatballs	1 oz.	400 – 225	3	12½ lb.	65	18 lb.	100
Pot Roast	2 oz.	350 – 200		120 lb.	500	180 lb.	750
Salisbury Steak	5 oz.	400	3	16 lb.	50	24 lb.	75
Sirloin Steak	6 oz.	400	5	15 lb.	40	22½ lb.	60
Swiss Steak	4 oz.	300 – 200	1	25 lb.	110	40 lb.	160

VG30, VG40, VE30 & VE40 BRAISING PANS

ITEM	PORTION SIZE	TEMP. (°F)	BATCHES PER HOUR	VG30/VE30 PER LOAD		VG40/VE40 PER LOAD	
				QTY.	PORTIONS	QTY.	PORTIONS
CHICKEN							
Pan Fried	2 – 1/4's	350	3	50 pieces	25	80 pieces	40
Whole	2 oz.	350 – 200		16 – 5 lb.	200	24 – 5 lb.	265
FRANKFURTERS							
Grilled	2 oz.	300	8	22 lb.	176	33 lb.	264
Boiled	2 oz.	250	12	16 lb.	128	25 lb.	200
PORK							
Ham Steak	3 oz.	400	8	10 lb.	50	15 lb.	75
Pork Chops	5 oz.	350	4	15 lb.	50	25 lb.	75
Sausage Links	3 links	350	7	30 lb.	120	45 lb.	180
TURKEY							
Off Carcass	2 oz.	400 – 200	—	3–26 to 30 lb.	200	4–26 to 30 lb.	275
On Carcass	2 oz.	400 – 200	—	4–16 to 20 lb.	175	6–16 to 20 lb.	265
MISCELLANEOUS							
Grilled Cheese Sandwich	1 sand.	400	8	40 sand.	40	50 sand.	50
Macaroni & Cheese	8 oz.	200	2	30 gal.	480	40 gal.	640
Rice	4 oz.	350 – 225	1	20 lb. raw	320	40 lb. raw	650
Spaghetti	4 oz.	350 – 225	2	8 lb. raw	200	12 lb. raw	300

COOKING GUIDELINES (Metric Measurements)

The guidelines given below are suggested quantities, temperature settings and estimated numbers of orders per load and per hour. When two temperatures are given, the first is to start the product and the second is to finish the product.

The following temperatures should be used:

	Temperature (°C)
Simmering	93.3 Max.
Sauteing	107 to 135
Searing	149 to 177
Frying	163 to 191
Grilling	177 to 218

ITEM	PORTION SIZE	TEMP. (°C)	BATCHES PER HOUR	VG30/VE30		VG40/VE40	
				PER LOAD QTY.	PORTIONS	PER LOAD QTY.	PORTIONS
BREAKFAST FOODS							
Bacon	3 Slices	177	12	0.9 kg	10	1.4 kg	15
Eggs							
–Boiled-Hard	1 egg	107	5	50 eggs	50	75 eggs	75
–Boiled-Soft	1 egg	107	8	50 eggs	50	75 eggs	75
–Fried	1 egg	204	4	30 eggs	30	45 eggs	45
–Poached	1 egg	107	5	36 eggs	36	60 eggs	60
–Scrambled	1½ eggs	149 – 93	1	68 L	720	106 L	1100
French Toast	3 slices	218	7	35 slices	12	50 slices	17
Regular Oatmeal	118 mL	121	2	9 kg	500	18 kg	1000
Pancakes	2 each	204	10	30 ea.	15	50 ea.	25
FISH							
Clams	473 mL	204	10	9 L	20	14 L	30
Fish Cakes	57 to 85 g	204	5	70 – 85 g	35	110 – 85 g	55
Haddock Fillet	113 g	204	4	60 – 113 g	60	90 – 113 g	90
Halibut Steak	142 g	218	3	60 – 113 g	60	90 – 113 g	90
Lobster	1 – 0.5 kg	177	4	20 – 0.5 kg	20	30 – 0.5 kg	30
Swordfish	142 g	218	3	50 – 142 g.	50	75 – 142 g	75
SAUCES, GRAVIES, SOUPS							
Brown Gravy	28 g	177 – 93	2	114 L	3840	151 L	5120
Cream Sauce	57 g	121 – 79	1	114 L	1920	151 L	2560
Cream Soup	170 g	93	1	114 L	640	151 L	853
French Onion Soup	170 g	107	1	114 L	640	151 L	853
Meat Sauce	113 g	177 – 93	1	114 L	960	151 L	1280

VG30, VG40, VE30 & VE40 BRAISING PANS

ITEM	PORTION SIZE	TEMP. (°C)	BATCHES PER HOUR	VG30/VE30 PER LOAD		VG40/VE40 PER LOAD	
				QTY.	PORTIONS	QTY.	PORTIONS
VEGETABLES							
CANNED	85 g	204	6	14 kg	125	20 kg	200
FRESH							
Beans, Wax, Green	85 g	204	3	11 kg	125	23 kg	250
Beets	85 g	204	1	14 kg	125	27 kg	300
Broccoli	85 g	204	3	11 kg	125	18 kg	200
Cabbage	85 g	204	5	9 kg	80	14 kg	125
Carrots	85 g	204	2	16 kg	150	32 kg	300
Cauliflower	85 g	121	5	7 kg	75	11 kg	125
Corn	1 Ear	204	8	50 ears	50	75 ears	75
Potatoes	85 g	204	2	18 kg	200	27 kg	300
Spinach	113 g	121	10	3 kg	25	4 kg	35
Turnips	113 g	204	2	9 kg	100	14 kg	150
FROZEN							
Beans, French Green	85 g	204	6	7 kg	60	10 kg	90
Lima Beans	85 g	121	4	7 kg	60	10 kg	90
Broccoli	85 g	204	8	5 kg	50	8 kg	75
Sliced Carrots	85 g	121	6	7 kg	60	10 kg	90
Small Whole Carrots	85 g	121	3	7 kg	50	10 kg	90
Corn	85 g	121	18	7 kg	50	10 kg	90
Small Whole Onions	85 g	121	7	7 kg	50	10 kg	90
Peas	85 g	204	10	7 kg	75	10 kg	110
Spinach	85 g	204	3	7 kg	75	10 kg	110
DESSERTS, PUDDINGS, SWEET SAUCES							
Butterscotch Sauce	28 g	93	1	114 L	3840	151 L	5120
Cherry Cobbler	85 g	93	1	114 L	1280	151 L	1707
Chocolate Sauce	28 g	93	1	114 L	3840	151 L	5120
Cornstarch Pudding	113 g	93	1	114 L	960	151 L	1280
Fruit Gelatin	85 g	121	2	114 L	1280	151 L	1707
MEAT – POULTRY							
Bacon	3 Slices	177	12	0.9 kg	10	1 kg	15
BEEF							
Amer. Chop Suey	170 g	204 – 107	2	114 L	640	151 L	853
Beef Stew	0.2 kg	149	—	114 L	480	151 L	640
Corned Beef Hash	142 g	204	5	9 kg	60	14 kg	90
Cheeseburger	85 g	149	12	3 kg	35	5 kg	50
Hamburger	85 g	149	15	3 kg	35	5 kg	50
Meatballs	28 g	204 – 107	3	6 kg	65	8 kg	100
Pot Roast	57 g	177 – 93		54 kg	500	82 kg	750
Salisbury Steak	142 g	204	3	7 kg	50	11 kg	75
Sirloin Steak	170 g	204	5	7 kg	40	10 kg	60
Swiss Steak	113 g	149 – 93	1	11 kg	110	18 kg	160

VG30, VG40, VE30 & VE40 BRAISING PANS

ITEM	PORTION SIZE	TEMP. (°C)	BATCHES PER HOUR	VG30/VE30		VG40/VE40	
				PER LOAD QTY.	PORTIONS	PER LOAD QTY.	PORTIONS
CHICKEN							
Pan Fried	2 – 1/4's	177	3	50 pieces	25	80 pieces	40
Whole	57 g	177 – 93		16 – 2 kg	200	24 – 2 kg	265
FRANKFURTERS							
Grilled	57 g	149	8	10 kg	176	15 kg	264
Boiled	57 g	121	12	7 kg	128	11 kg	200
PORK							
Ham Steak	85 g	204	8	5 kg	50	7 kg	75
Pork Chops	142 g	177	4	7 kg	50	11 kg	75
Sausage Links	3 links	177	7	14 kg	120	10 kg	180
TURKEY							
Off Carcass	57 g	204 – 93	—	3 – 12 to 14 kg	200	4 – 12 to 14 kg	275
On Carcass	57 g	204 – 93	—	4 – 7 to 9 kg	175	6 – 7 to 9 kg	265
MISCELLANEOUS							
Grilled Cheese Sandwich	1 sand.	204	8	40 sand.	40	50 sand.	50
Macaroni & Cheese	0.2 kg	93	2	114 L	480	151 L	640
Rice	113 g	177 – 107	1	9 kg raw	320	18 kg raw	650
Spaghetti	113 g	177 – 107	2	4 kg raw	200	5 kg raw	300

MAINTENANCE



⚠ WARNING Disconnect the electrical power to the machine and follow Lockout / Tagout procedures before performing any maintenance.

⚠ WARNING The tilting braising pan and its parts are hot. Use care when operating, cleaning or servicing the braising pan.

LUBRICATION

Lid Mechanism

1. The lid lift mechanism and tension spring are located behind the backsplash (sheet metal panel behind the braising pan) on both the left and right rear corners of the braising pan.
2. Take the cover off by prying and lifting up (Fig. 7).
3. For smooth operation of the lid, lubricate these mechanisms with 8 to 10 drops of lubricating machine oil every 6 months. Place a few drops of oil between the lid arm and stationary block, and a few drops on the shaft around which the spring is coiled.
4. Replace the cover to maintain smooth operation.

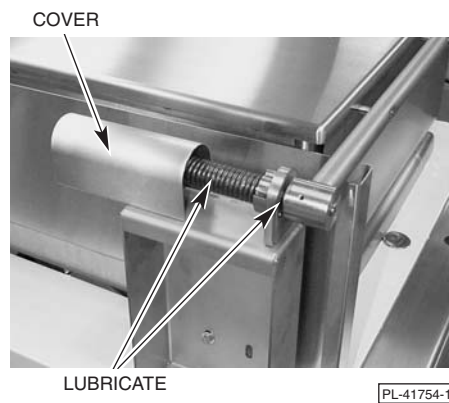

Fig. 7

ADJUSTMENTS

At least twice a year, have a Vulcan-Hart authorized service person clean and adjust the tilting braising pan for maximum performance.

FLUE

When cool, annually check the flue. Clean the flue of any grease buildup or other obstructions that can affect the flow of the flue gases from the braising pan.

TROUBLESHOOTING

GAS HEAT BRAISING PANS

Problem	Possible Cause
Burners do not come on.	<ol style="list-style-type: none"> 1. The power is off or unit is unplugged. 2. The gas supply to the braising pan is off. 3. The thermostat is not set. 4. The internal gas combine valve is off. 5. The pan is not in the lowest position. 6. Problem with the gas control system. Contact your Vulcan-Hart authorized servicer.
Burners have yellow flame.	<ol style="list-style-type: none"> 1. Braising pan frame is not level. 2. Wrong gas supply type (contact plumber or building maintenance). 3. Incorrect pressure at supply.

ELECTRIC HEAT BRAISING PANS

Problem	Possible Cause
Heating elements do not come on.	<ol style="list-style-type: none"> 1. The power supply is off. 2. The thermostat is not set. 3. Blown fuse in field electrical box. 4. Pan is not in the lowest position. 5. Problem with the control circuits. Contact your Vulcan-Hart authorized servicer.

SERVICE AND PARTS INFORMATION

To obtain service and parts information concerning this model, contact the Vulcan - Hart Service Agency in your area (refer to our website, www.vulcanhart.com for a complete listing of Authorized Service and Parts deports).

When calling for service, the following information must be available: model number, serial number, manufacture date (MD) and gas type or voltage.